

Kwik-Bite® Senso

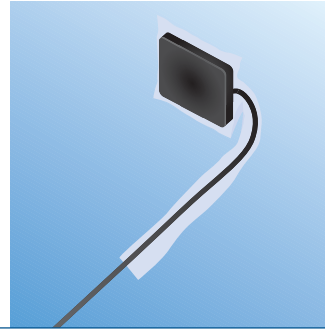

EP Pat. 1.402.818 / US Pat. 6.905.244 / Other Pat. Pend.

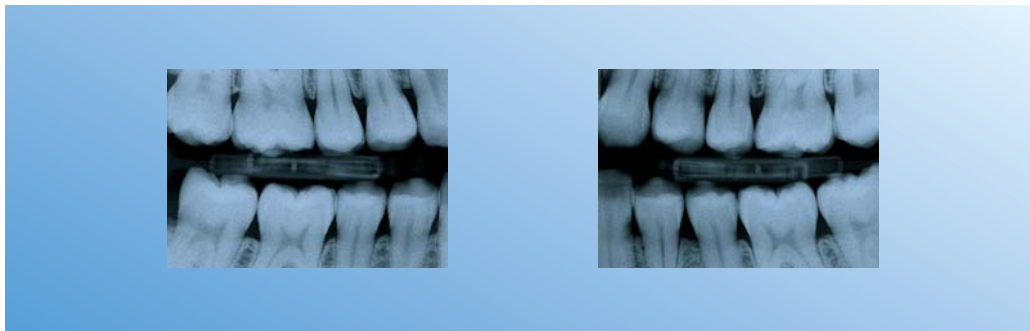
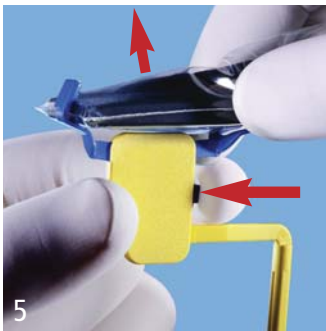
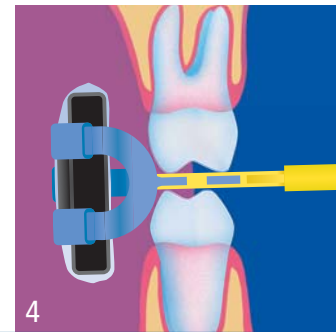
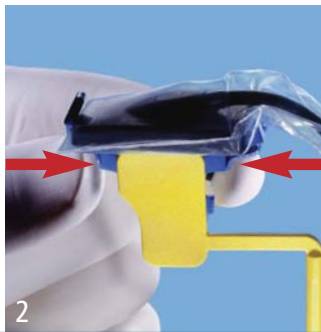
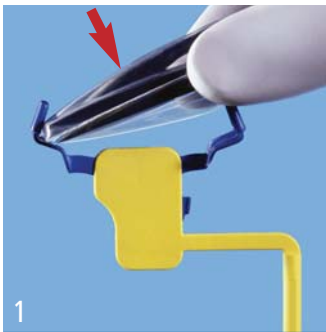

514898-AG

Manufactured by
KerrHawe SA
Via Strece 4
6934 Bioggio/Switzerland
www.KerrHawe.com
00800 41 05 05 05



Kerr U.S.A.
1717 West Collins Avenue
Orange, CA 92867
(800) KERR-123
KerrDental.com

Kerr Australia Pty. Ltd.
Unit 11, 112-118 Talavera Road
North Ryde 2113
New South Wales, Australia
61-29-870-7500

Sybron Dental Specialities Japan, Inc.
29-24 Honkomagone 2-chome
Bunkyo-ku, Tokyo
113-0021 Japan
0120-18-3126

Distributed in North America and Canada exclusively by
Pinnacle Products Inc.
21401 Hemlock Avenue
Lakeville, MN 55044 USA
952.469.2445
800.878.3902 (US only)
www.pinnacleproducts.com

Kwik-Bite® Senso

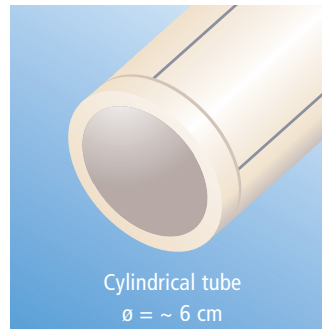

Cylindrical tube
 $\varnothing = \sim 6 \text{ cm}$



Rectangular tube

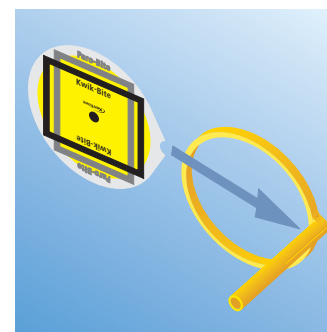

Manufactured by
KerrHawe SA
Via Strecce 4
6934 Bioggio/Switzerland
www.KerrHawe.com
00800 41 05 05 05



Kerr U.S.A.
1717 West Collins Avenue
Orange, CA 92867
(800) KERR-123
KerrDental.com

Kerr Australia Pty. Ltd.
Unit 11, 112-118 Talavera Road
North Ryde 2113
New South Wales, Australia
61-29-870-7500

Sybron Dental Specialities Japan, Inc.
29-24 Honkomagone 2-chome
Bunkyo-ku, Tokyo
113-0021 Japan
0120-18-3126

Distributed in North America and Canada exclusively by
Pinnacle Products Inc.
21401 Hemlock Avenue
Lakeville, MN 55044 USA
952.469.2445
800.878.3902 (US only)
www.pinnacleproducts.com

Endo-Bite Senso Anterior

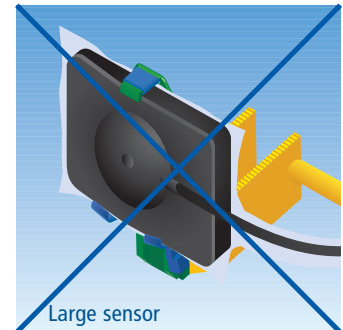
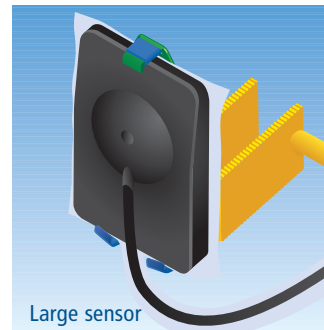
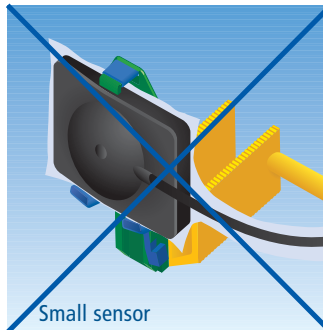
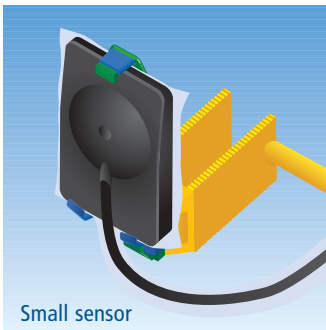
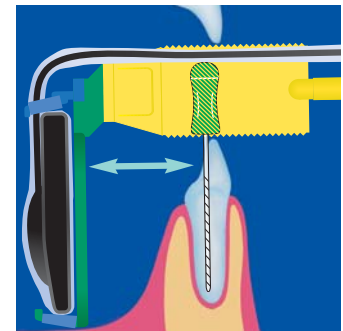
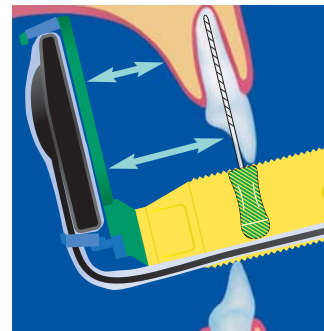
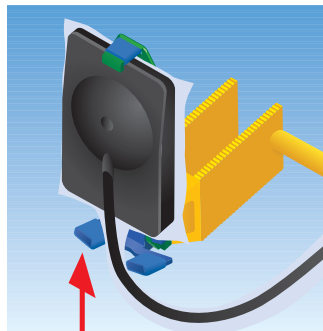
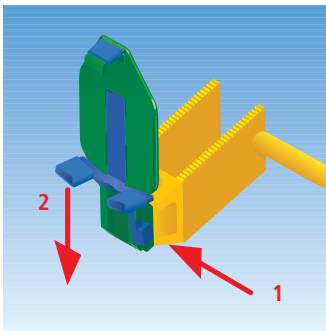
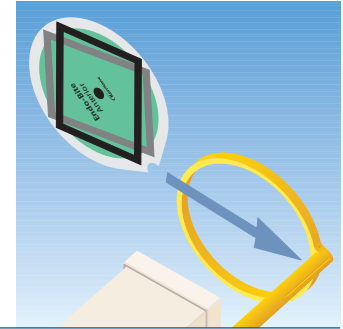
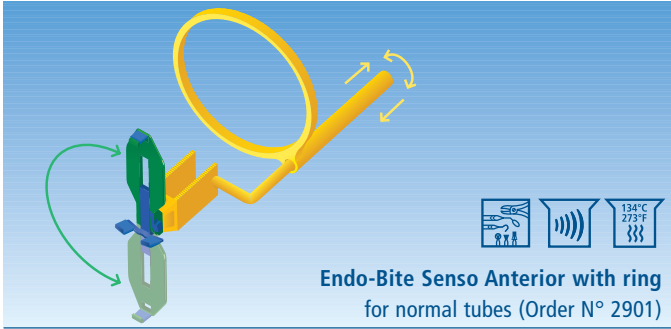

EP Pat. 0 397 599 / US Pat. 5 044 009 / EP Pat. 1 402 818 / US Pat. 6 905 244 / Other Pat. Pending

510888-KF

Manufactured by
KerrHawe SA
Via Strecce 4
6934 Bioggio/Switzerland
www.KerrHawe.com
00800 41 05 05 05



Kerr U.S.A.
1717 West Collins Avenue
Orange, CA 92867
(800) KERR-123
KerrDental.com

Kerr Australia Pty. Ltd.
Unit 11, 112-118 Talavera Road
North Ryde 2113
New South Wales, Australia
61-29-870-7500

Sybron Dental Specialties Japan, Inc.
29-24 Honkomagone 2-chome
Bunkyo-ku, Tokyo
113-0021 Japan
0120-18-3126

Distributed in North America and Canada exclusively by
Pinnacle Products Inc.
21401 Hemlock Avenue
Lakeville, MN 55044 USA
952.469.2445
800.878.3902 (US only)
www.pinnacleproducts.com

Endo-Bite Senso Posterior

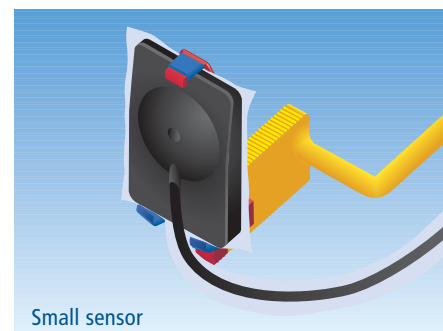
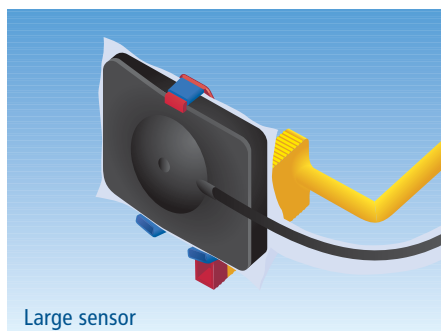
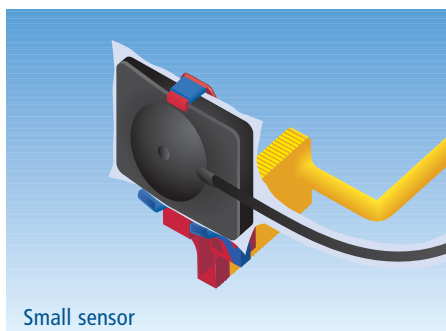
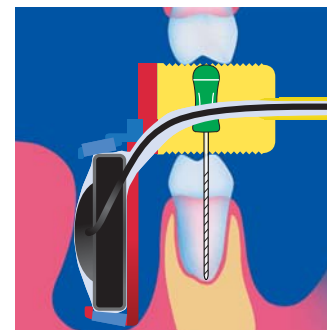
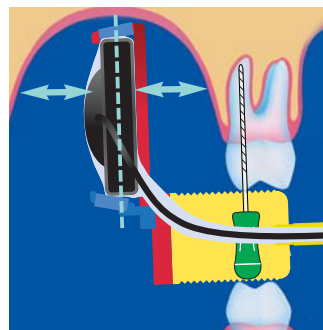
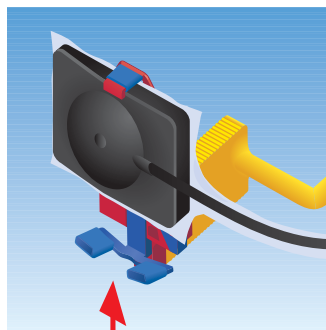
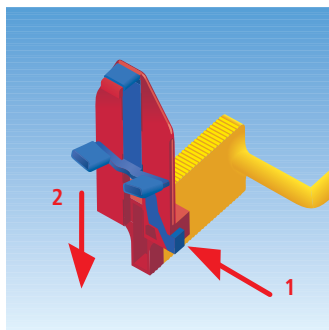
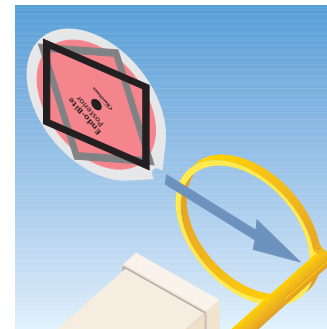
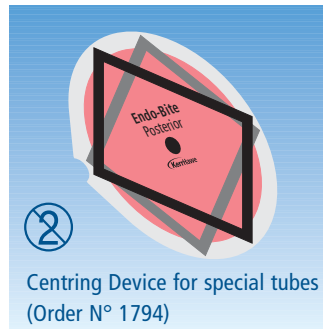
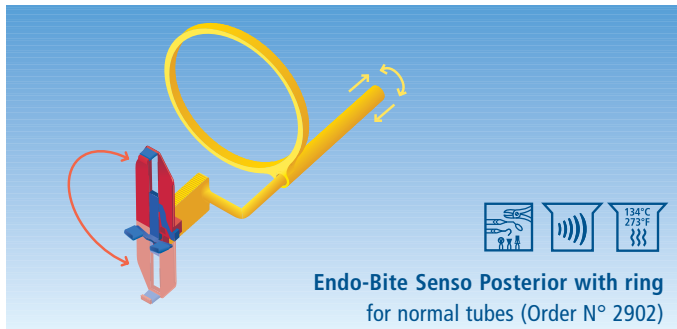

EP Pat. 0 397 599 / US Pat. 5 044 009 / EP Pat. 1 402 818 / US Pat. 6 905 244 / Other Pat. Pending

Manufactured by
KerrHawe SA
Via Strece 4
6934 Bioggio/Switzerland
www.KerrHawe.com
00800 41 05 05 05



Kerr U.S.A.
1717 West Collins Avenue
Orange, CA 92867
(800) KERR-123
KerrDental.com

Kerr Australia Pty. Ltd.
Unit 11, 112-118 Talavera Road
North Ryde 2113
New South Wales, Australia
61-29-870-7500

Sybron Dental Specialities Japan, Inc.
29-24 Honkomagoe 2-chome
Bunkyo-ku, Tokyo
113-0021 Japan
0120-18-3126

Distributed in North America and Canada exclusively by
Pinnacle Products Inc.
21401 Hemlock Avenue
Lakeville, MN 55044 USA
952.469.2445
800.878.3902 (US only)
www.pinnacleproducts.com

Super-Bite® Senso Anterior



CE EU Representative
Kerr Italia S.p.A.
Via Pasconi 3/2
84018 Scafati (SA), Italy

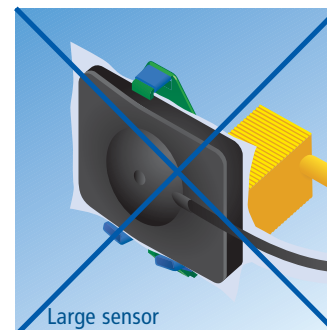
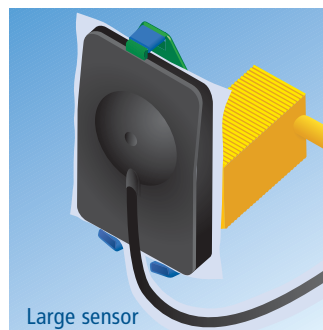
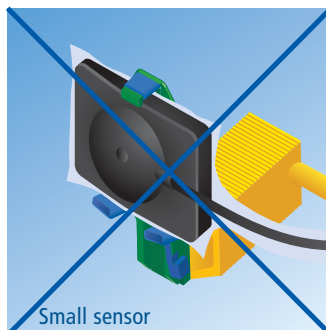
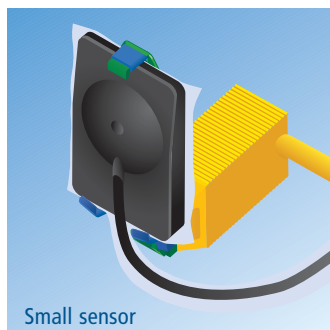
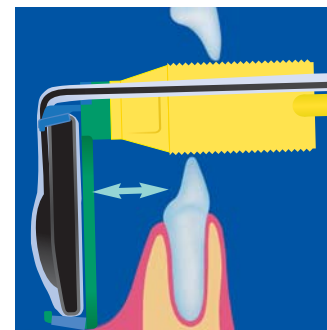
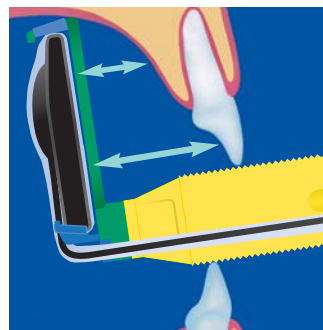
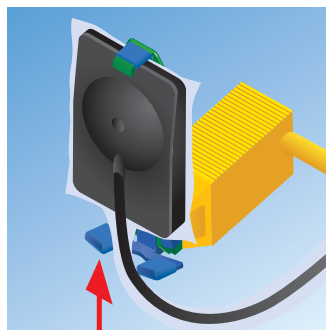
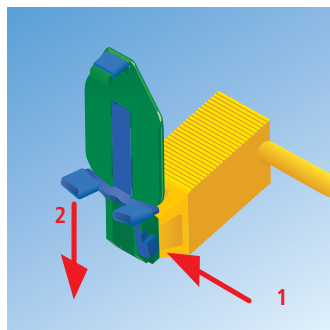
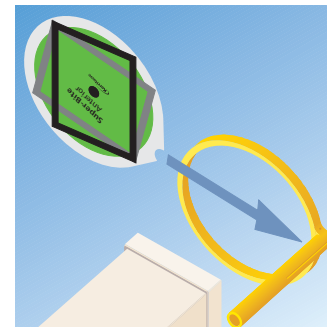
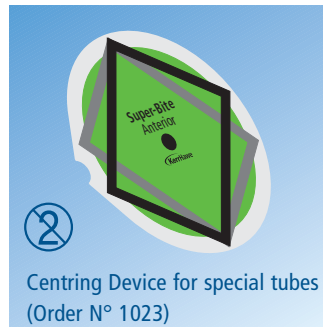
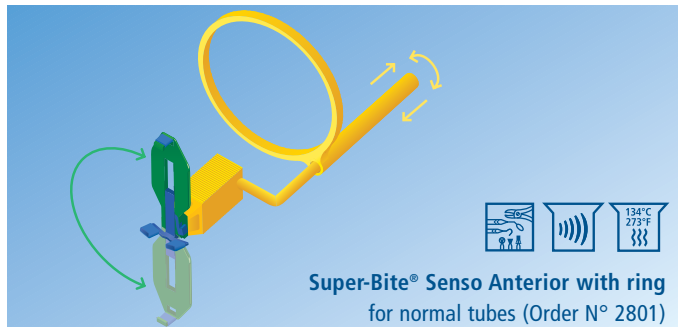

Manufactured by
KerrHawe SA
Via Strecce 4
6934 Bioggio/Switzerland
www.KerrHawe.com
00800 41 05 05 05



Kerr U.S.A.
1717 West Collins Avenue
Orange, CA 92867
(800) KERR-123
KerrDental.com

Kerr Australia Pty. Ltd.
Unit 11, 112-118 Talavera Road
North Ryde 2113
New South Wales, Australia
61-29-870-7500

Sybron Dental Specialties Japan, Inc.
29-24 Honkomagone 2-chome
Bunkyo-ku, Tokyo
113-0021 Japan
0120-18-3126

Distributed in North America and Canada exclusively by
Pinnacle Products Inc.
21401 Hemlock Avenue
Lakeville, MN 55044 USA
952.469.2445
800.878.3902 (US only)
www.pinnacleproducts.com

EP Pat. 0 397 599 / US Pat. 5 044 009 / EP Pat. 1 402 818 / US Pat. 6 905 244 / Other Pat. Pend.

504897-AG

Super-Bite® Senso Posterior



CE EU Representative
Kerr Italia S.p.A.
Via Pasaroni 332
84018 Scafati (SA), Italy

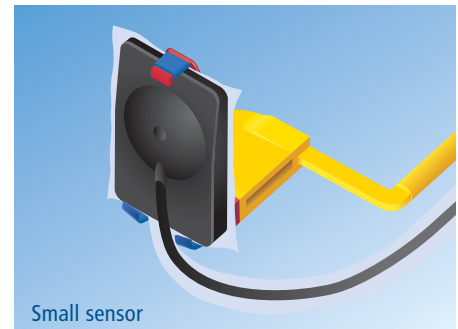
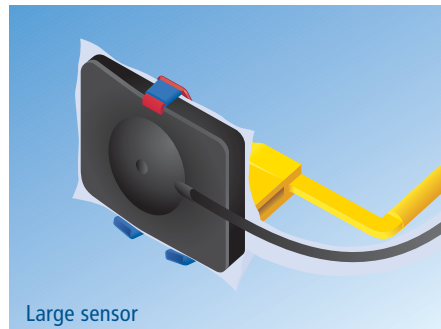
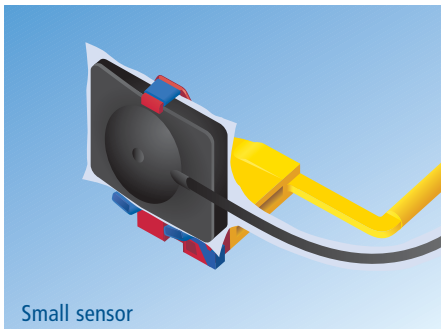
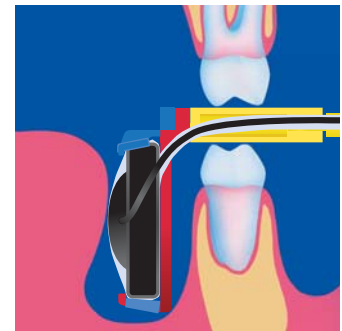
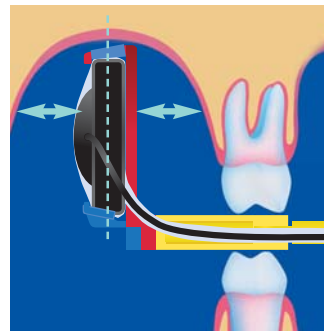
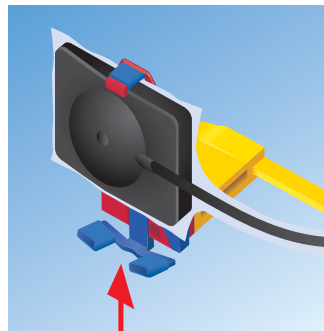
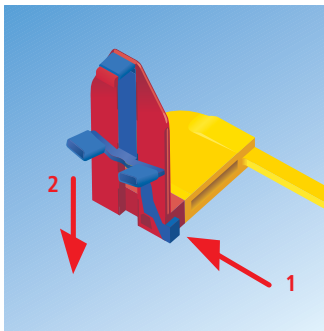
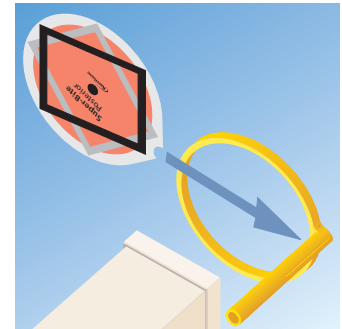
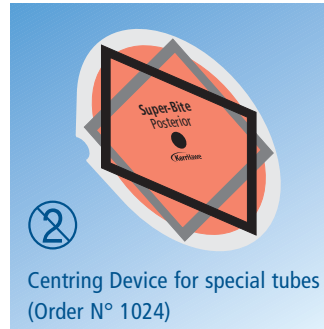
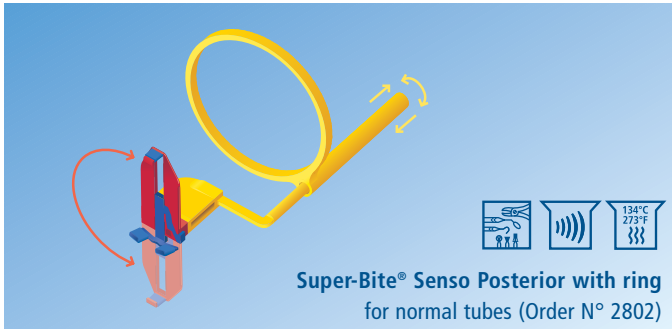

EP Pat. 0 397 599 / US Pat. 5 044 009 / EP Pat. 1 402 818 / US Pat. 6 905 244 / Other Pat. Pend.

Manufactured by
KerrHawe SA
Via Strece 4
6934 Bioggio/Switzerland
www.KerrHawe.com
00800 41 05 05 05



Kerr U.S.A.
1717 West Collins Avenue
Orange, CA 92867
(800) KERR-123
KerrDental.com

Kerr Australia Pty. Ltd.
Unit 11, 112-118 Talavera Road
North Ryde 2113
New South Wales, Australia
61-29-870-7500

Sybron Dental Specialities Japan, Inc.
29-24 Honkomagone 2-chome
Bunkyo-ku, Tokyo
113-0021 Japan
0120-18-3126

Distributed in North America and Canada exclusively by
Pinnacle Products Inc.
21401 Hemlock Avenue
Lakeville, MN 55044 USA
952.469.2445
800.878.3902 (US only)
www.pinnacleproducts.com